

# Prime Recessed RGBCW WIFI LED Downlight Installation Instructions

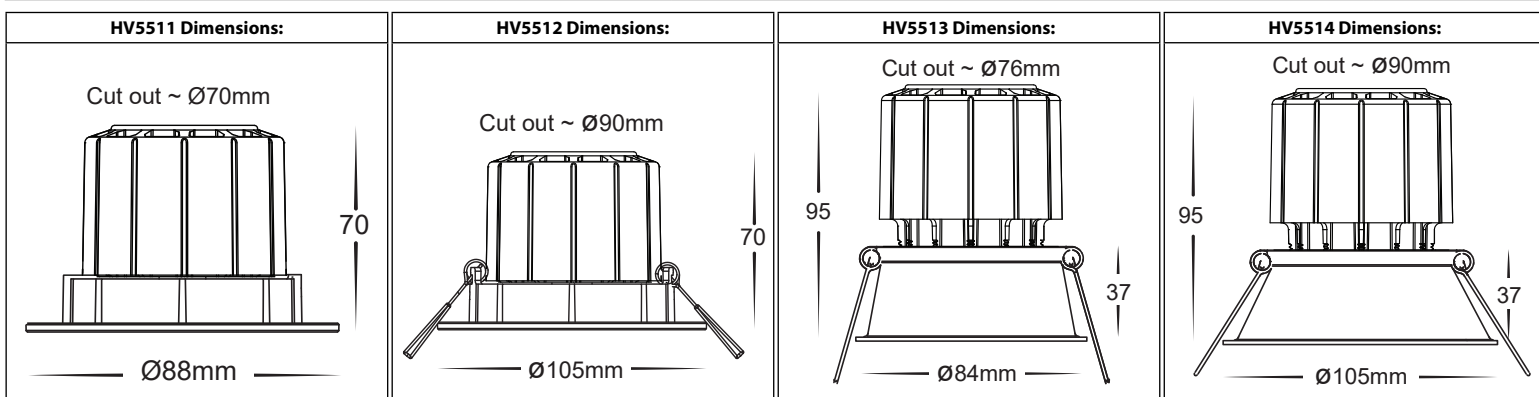

## Product Specifications

Model No.	HV5511CCT-BLK	HV5511CCT-WHT	HV5512CCT-BLK	HV5512CCT-WHT	HV5513CCT-BLK	HV5513CCT-WHT	HV5514CCT-BLK	HV5514CCT-WHT
Name	Prime							
Material	Aluminium							
Colour	Black	White	Black	White	Black	White	Black	White
Cut Out	70mm		90mm		76mm		90mm	
IC Rating	IC-4							
IP Rating	IP54 - Front of fitting only							
Input Voltage	240v AC							
Protection Class	2 (No Earth Required) <input type="checkbox"/>							
Lamp Base	Built in LED							
Lamp Wattage	1x 12w							
Colour Temp	RGBCW							
Lumens	300lm - 320lm							
CRI	> 90							
Dimmable	Yes - Via APP							
Warranty	3 Years Replacement*							



### Important Safety Issues:

- This product must be installed by a qualified electrician according to AS/NZS 3000.
- Ensure all electrical mains are disconnected before any installation.
- Modification of this product will void any warranty.
- Havit Lighting does not take responsibility for wrong installation, incorrect use, or use of installation material that does not belong to the system.
- Aluminium and 304SS fittings must not be installed within 5km of any salt water environments.
- Only LED Fitting can be installed under insulation, LED Driver must not be covered to allow for ventilation.
- This fixture must not be installed with loose fill insulation such as macerated paper and wool. LED driver must be mounted above any insulation covering the fixture.
- These instructions may be updated at any time due to product improvements. Please visit our website for most current installation instructions.

### Installation Diagram:

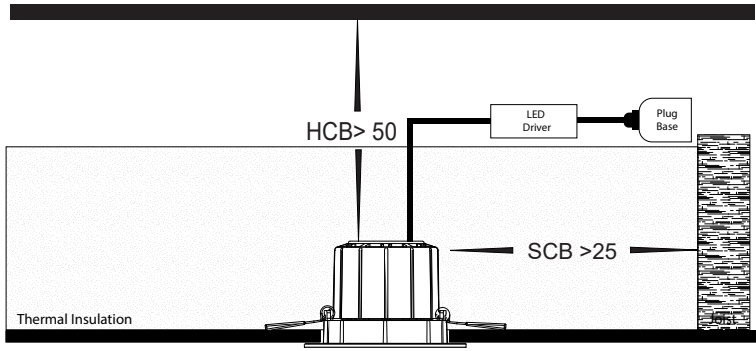

### Steps for Installation:

1. Make sure that the electrical circuit is free of voltage (master switch off)
2. Cut out hole using dimensions in table and on line drawings above for model purchased making sure each hole is not under joist or pipes.
3. Fitting is provided with flex and plug, Plug cable into plug base installed earlier.
4. Before installing downlight, Make sure LED Driver is not covered by any insulation.
5. Pull back springs on fitting and insert into hole.
6. Once fitting is in hole, release clips, These springs will hold fitting in place.
7. All connections must be carried out carefully, inspect all contacts before switching back on the electric circuit.
8. Refer to following pages for Setup of Downlight to APP

## Must be installed by a licensed electrician

### Contact Details:

143 Beauchamp Road  
Matraville NSW 2036  
Australia

Tel: 02 9381 8300  
Fax: 02 9666 8881  
Email: sales@havit.com.au  
Web: www.havit.com.au

### Warranty Terms & Conditions\*



### Additional Information



**Step 2:** Download TUYA SMART APP from either APP store or Google Play and register an account, Once regeistered, login to account to start pairing process.

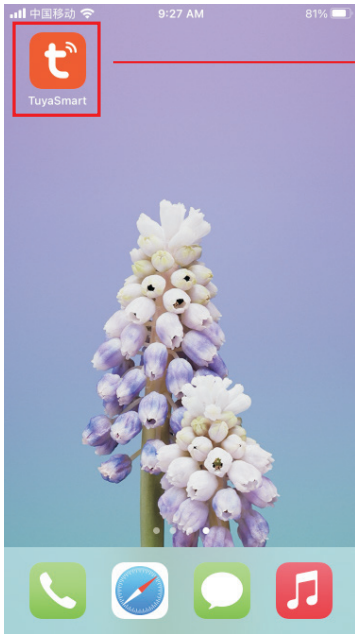

Tap to run the App.

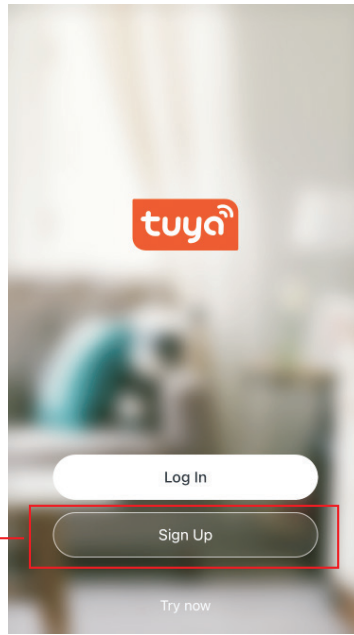

Tap Sign Up.

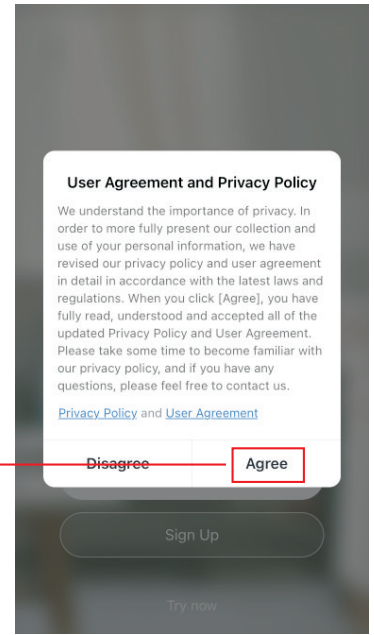

Tap Agree.

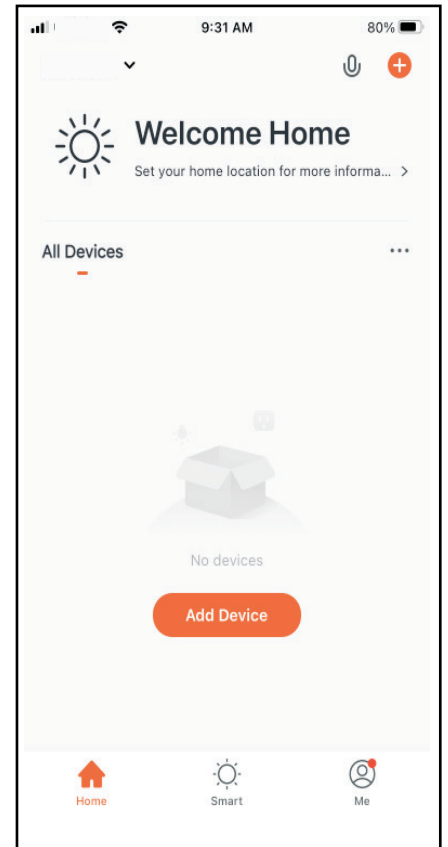
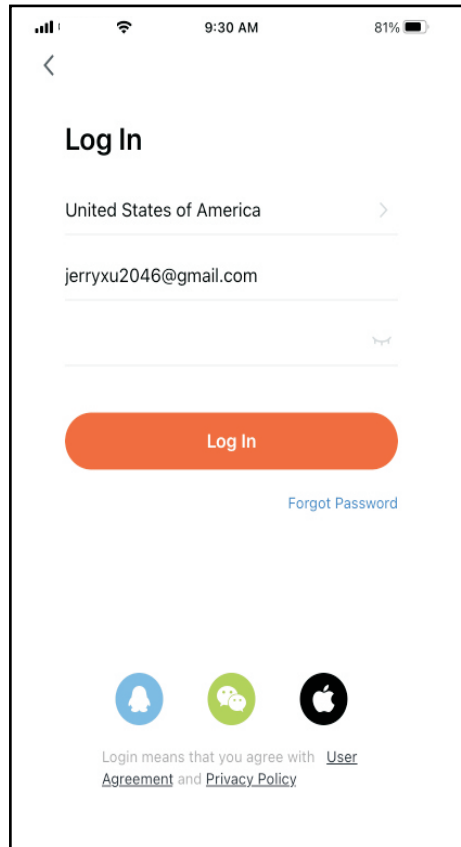
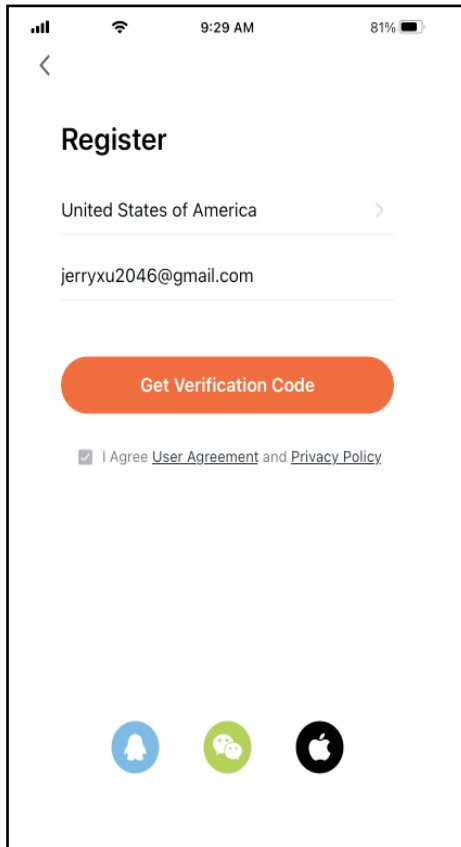

**Must be installed by a licensed electrician**

**Contact Details:**

143 Beauchamp Road  
Matrville NSW 2036  
Australia

Tel: 02 9381 8300  
Fax: 02 9666 8881  
Email: sales@havit.com.au  
Web: www.havit.com.au

**Warranty Terms & Conditions\***



**Additional Information**



**Step 2:** Switch on Downlight to initiate pairing mode, Downlight will flash to indicate that pairing mode is active, APP Should discover light fitting otherwise Press add device in top right corner and follow steps below.

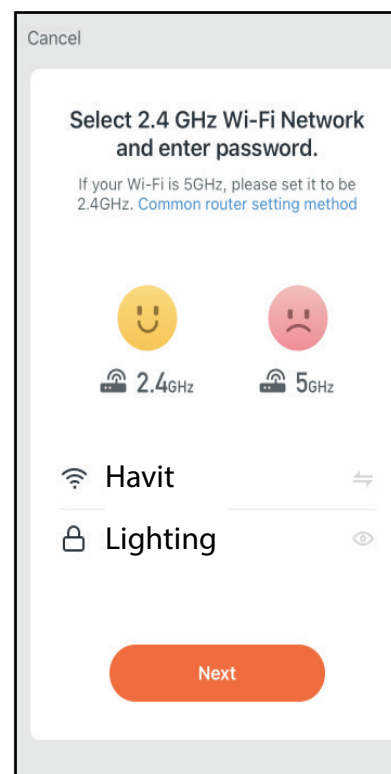
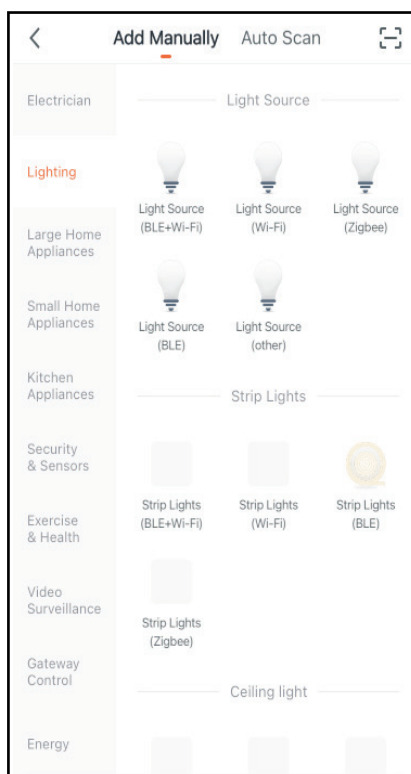
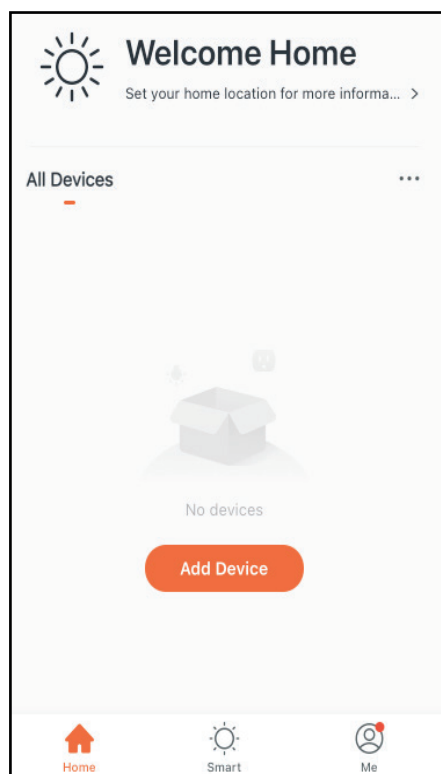

**Step 3:** Light will stop flashing once paired, Rename light fitting and press done when completed.

**Step 4:** APP Will return to home screen, from there you can select light fitting to adjust colour temperature and brightness.

**To Group multiple light fittings follow steps below.**

Step 1: Select 1 of the light fittings to be in the group

Step 2: Press edit button at the top right of screen.

Step 3: Press Create Group

Step 4: Select light fittings that you want to be in the group and press save.

Step 5: Enter group name and press save.

**Must be installed by a licensed electrician**

Contact Details:	Warranty Terms & Conditions*	Additional Information
143 Beauchamp Road Matraville NSW 2036 Australia Tel: 02 9381 8300 Fax: 02 9666 8881 Email: sales@havit.com.au Web: www.havit.com.au		

## To reset light fitting follow steps below.

**Step 1:** Switch light fitting on and off 5 times to reset, Light fitting will start flashing and enter pairing mode.

**Step 2:** Follow pairing mode steps to add light fitting to APP.

## APP Functions:

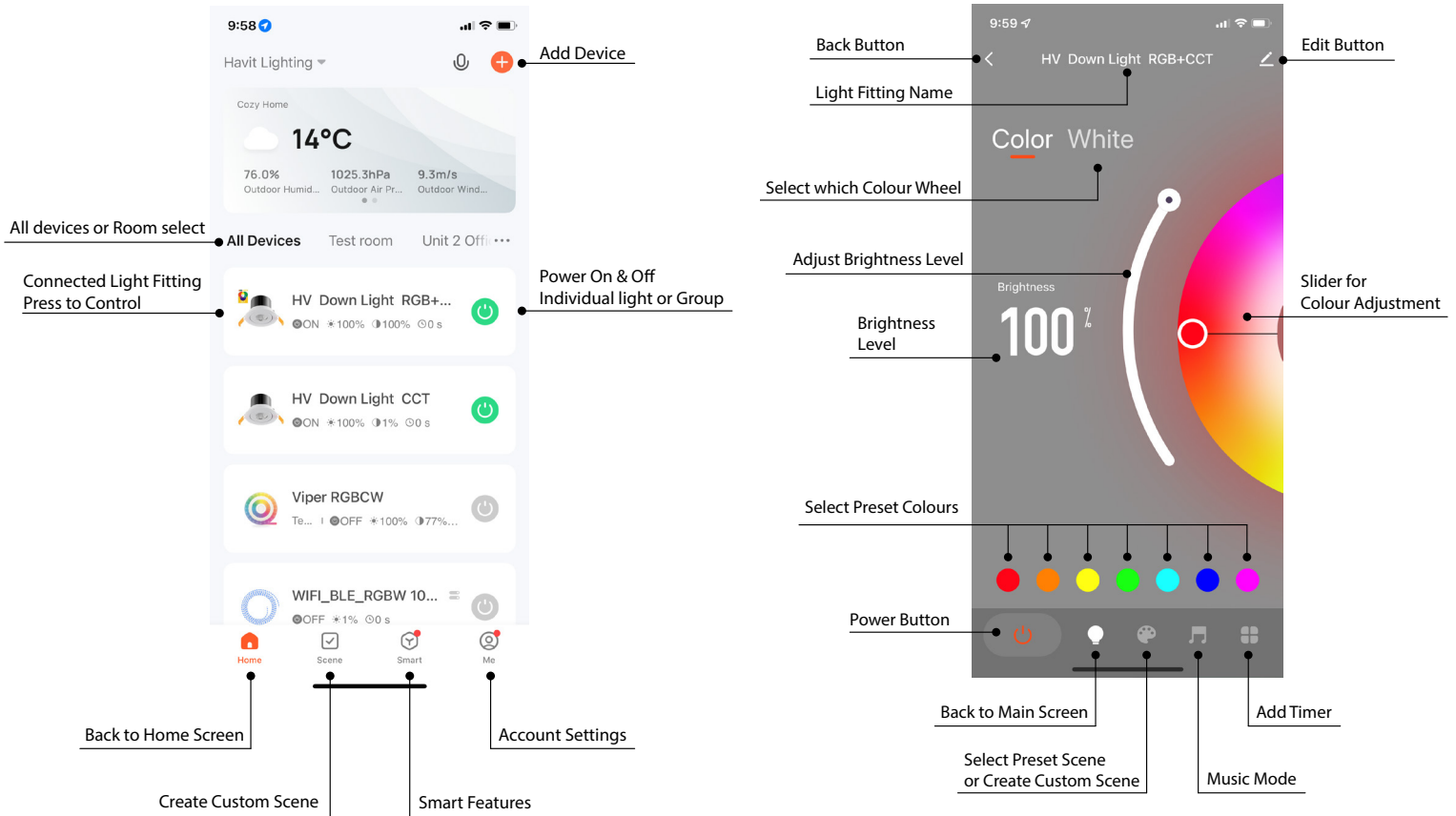

## Screenshots

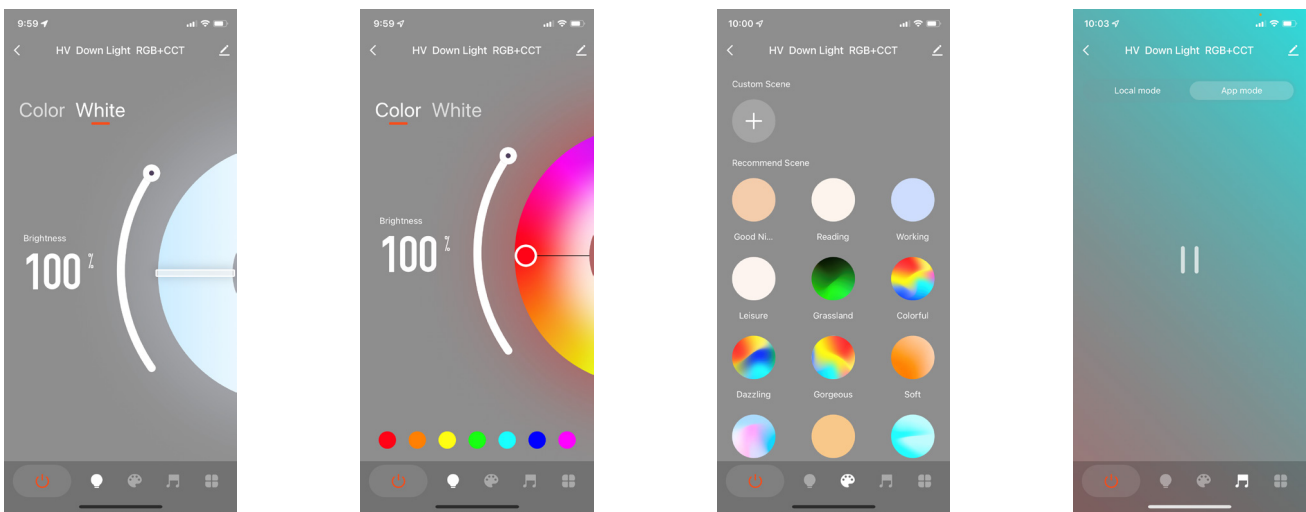

**Must be installed by a licensed electrician**

### Contact Details:

143 Beauchamp Road  
Matrville NSW 2036  
Australia

Tel: 02 9381 8300  
Fax: 02 9666 8881  
Email: sales@havit.com.au  
Web: www.havit.com.au

### Warranty Terms & Conditions\*



### Additional Information

