

14.4w IP20 24v DC 240LED Micro LED Strip

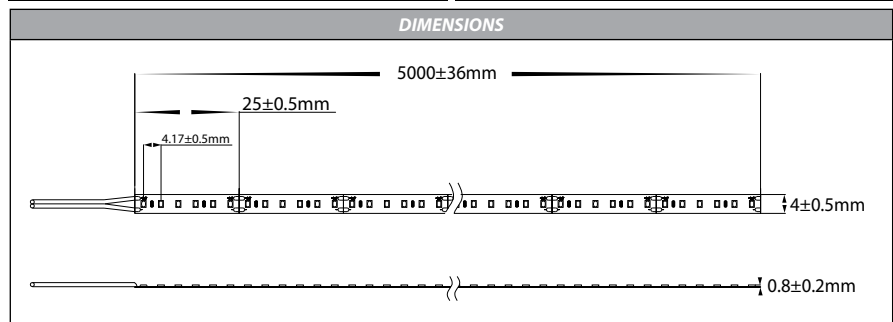

Product Specifications

Watts Per Metre	14.4w
Input Voltage	24v DC
Colour Temp	3000K 4000K 5500K
Beam Angle	120°
IP Rating	IP20
Size	4mm (W) x 2mm (H)
PCB	3oz
CRI	>80
Lamp Expectancy	>50000hrs
Wiring	Parallel
Dimmable	Yes
LED Chip Type	2216
No. Chips Per Metre	240
Maximum Length	5000mm
Cutting Increments	25mm
Mounting	Aluminium Profile or Heat Sink
Operating Temperature	0 - + 60° Celcius
Ambient Temperature	-20° - + 50° Celcius
Warranty	3 Years Replacement*



COMPATIBLE CONTROLLERS

Touch Panels	Remote Controllers	Zigbee	RF + WIFI
 HV9101-E1 HV9101-EX15	 HV9102-M1+M4-5A HV9102-Q1	 HV9101-ZB-SCTP HV9102-ZB-SCREM	 HV9101-2830A HV9102-2819DIM
 HV9103-F4-5A	 HV9103-F4-5A	 HV9105-ZB-5C	 HV9105-1009-5C

Product Ordering - Per Metre

Image	Part Number	Colour Temp	Lumens	Barcode
	HV9734-IP20-240-3K	3000k	1150lm	9350418023988
	HV9734-IP20-240-4K	4000k	1175lm	9350418024190
	HV9734-IP20-240-5K	5500k	1200lm	9350418024404

Product Ordering - 30m Reels

Image	Part Number	Colour Temp	Lumens	Barcode
	HV9734-IP20-240-3K-30M	3000k	1150lm	9350418031525
	HV9734-IP20-240-4K-30M	4000k	1175lm	9350418031532
	HV9734-IP20-240-5K-30M	5500k	1200lm	9350418031549

*Ordered after 01-01-2022

For More Information Contact Havit Lighting

143 Beauchamp Road
Matraville NSW 2036
Australia

Tel: 02 9381 8300
Fax: 02 9666 8881
Email: sales@havit.com.au
Web: www.havit.com.au



Warranty Terms & Conditions



www.havit.com.au