

150W DALI + Push Dim Constant Voltage IP66 LED Driver

Material	Aluminium
Colour	Anodised Grey
IP Rating	IP66
Input Voltage	100v - 240v AC
Output Voltage	Available in either 12v DC or 24v DC
Max Wattage	150w (Recommended Max Wattage 120w)
Protection Class	1 (Earth Required)
Dimming Methods	DALI or Push Dim
Dimming Range	1% - 100%
Protections	Short Circuit, Overload, Over Temperature
Warranty	3 Years Replacement

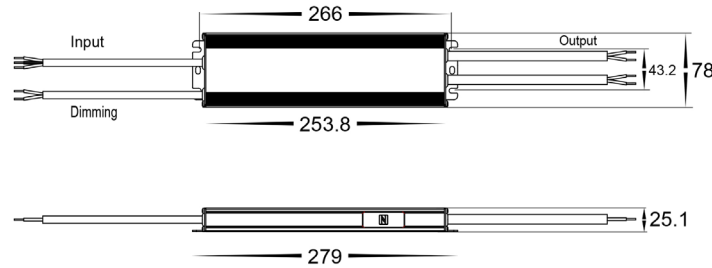

Dimensions



Product Ordering

Part Number	Output Voltage	Barcode
HV96631-12V150W	12v DC Constant Voltage	9350418027580
HV96631-24V150W	24v DC Constant Voltage	9350418027641



Website



Warranty
Terms & Conditions

Sample Wiring Diagrams

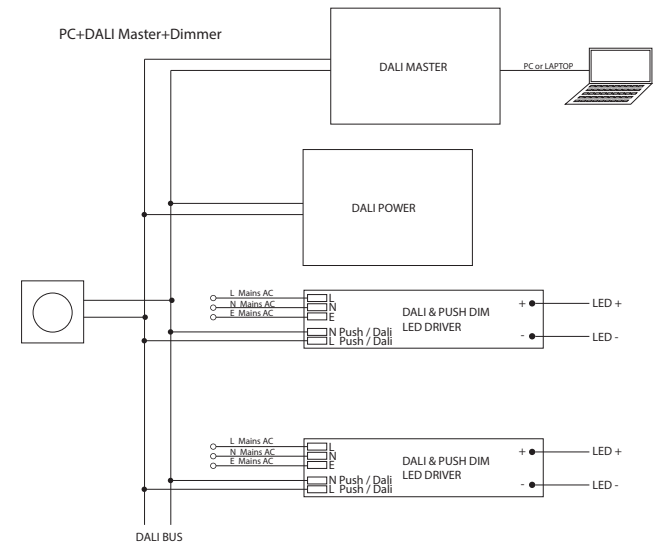
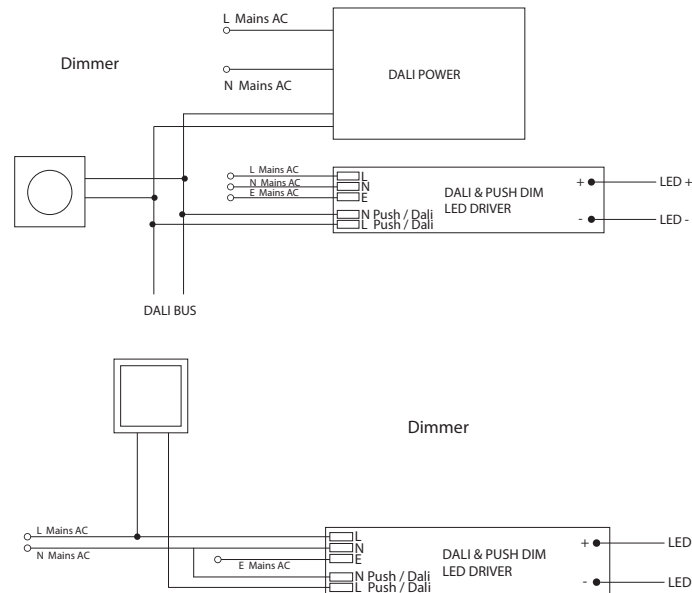

Part Number		HV96631-12V150W	HV96631-24V150W
Output	DC Voltage	12v DC (12-13.5V Adjust by NFC)	24v DC (24-26V Adjust by NFC)
	Voltage Tolerance	± 0.2V	
	Rated Current	12.5A	6.25A
	Rated Power	150W	
	Load Regulation	±2%	
Input	Standby Power Consumption	≤ 0.5W	≤ 0.5W
	Voltage Range	100-277V AC	
	Frequency Range	47 - 63Hz	
	Power Factor (TYP) @ Full Load	PF≥0.98 @ 120V AC PF≥0.96 @ 230V AC PF≥ 0.95 @ 277V AC (Full Loading)	
	THD(Typ.) @ Full Load	≤10% @ 120V AC ≤ 10% @ 230V AC ≤15% @ 277V AC	
	Efficiency(Typ.)@ Full Load	89% @ 120V AC 91% @ 230V AC 91% @ 277V AC	
	AC Current (Max)	1.65A	1.65A
	Inrush Current (TYP)	38.4A, 510us@50% Ipeak (120V AC)	
		88A, 120us@50% Ipeak (230V AC)	
		48A, 560us@50% Ipeak (277V AC)	
Leakage Current	<0.5mA		
Protections	Short Circuit	Hiccup mode, Recover automatically after fault condition is removed	
	Overload	≤120%, Hiccup mode, Recover automatically after fault condition is removed	
	Over Temperature	Ambient Temperature over 55°C ± 10°C, Output will turn off and recovers automatically after temperature drops	
Environment	Working Temp.	-40°-+60°C ,	
	Working Humidity	20 - 90%RH, Non Condensing	
	Storage TEMP. Humidity	-40 - +80°C, 10 - 95% RH	
	TEMP. Coefficient	± 0.03%/°c (0-50°c)	
	Vibration	10~500Hz, 2G 10min./1 Cycle, Period for 60min, each along X,Y,Z axes	
Safety & EMC	Safety Standards	EN61347-1	
	Isolation Resistance	I/P-O/P: 100MΩ / 500VDC / 25°c/ 70%RH Ω	
	EMC Emission	EN55015 EN61000-3-2,3(≥50%) (EU) & FCC Part 15 Subpart B(US)	
	EMC Immunity	EN61000-4-2,3,4,5,6,11 EN61547	
Others	Weight	0.35Kg	

Havit Lighting 143 Beauchamp Road, Matraville, N.S.W. 2036 | Phone: 02 9381 8300 |
 Fax: 02 9381 6661 | Email: sales@havit.com.au | Web: www.havit.com.au

