

Flame 316 Stainless Steel

Smart CCT Deck Lights

Name	Flame
Material	316 Stainless Steel
Colour	Stainless Steel
Cut Out	28mm
IP Rating	IP67
Lamp Base	Built in LED
Max Wattage	0.5w
Protection Class	LED Driver = 2 (No Earth Required) Fitting = 3 (No Earth Required)
Lamp Expectancy	>30,000 hrs
Diffuser Type	Opal Glass
Cable Length	2x 1500mm
CRI	CRI>80
Dimmable	Yes, using CCT Controller or Tuya App
IK Rating	IK05
Warranty	3 Years Replacement



Driver, Remote Control, Wifi Receiver and 4m Extension Cable Supplied with 6 Light Kit

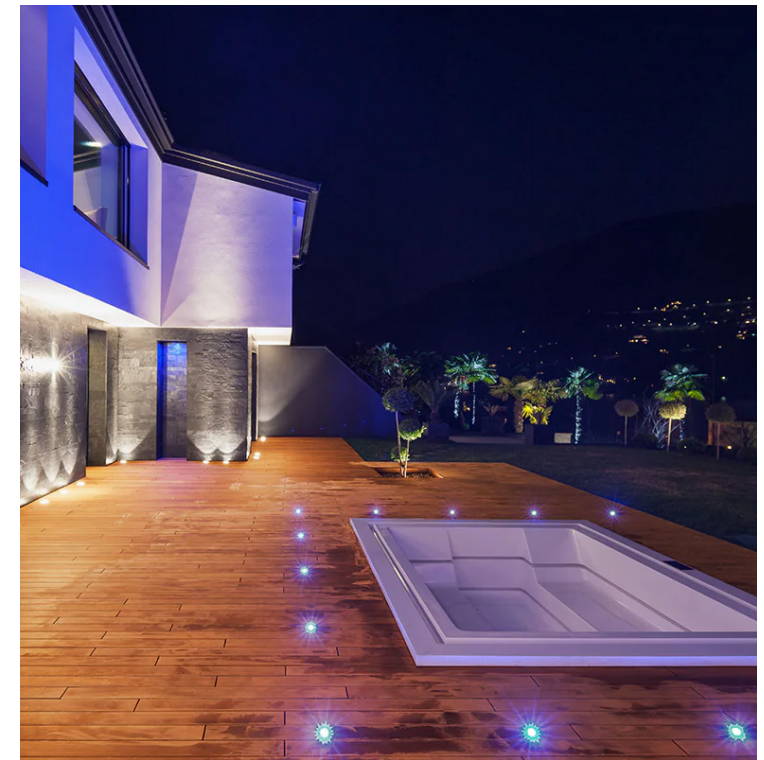

Installation Diagram

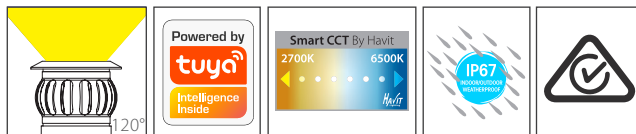
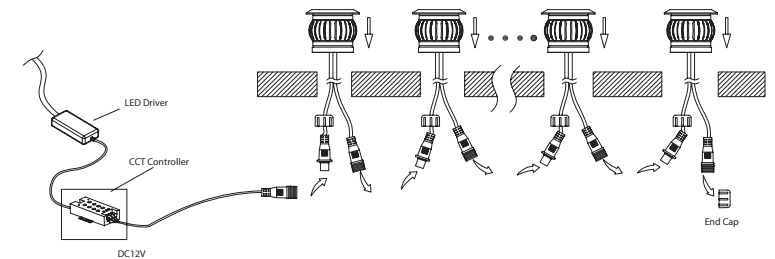



Warranty Terms & Conditions Website



Havit Lighting 143 Beauchamp Road, Matraville, N.S.W. 2036 | Phone: 02 9381 8300 | Fax: 02 9381 6661 | Email: sales@havit.com.au | Web: www.havit.com.au

Product Ordering

Image	Part Number	Colour Temp	Lumens	Input Voltage	Beam Angle	Included LED	Barcode
	HV28261CCT	2700K - 6500K	25lm	12v DC	120°	0.5w Built in LED	9350418038210
	HV2826CCT		6x 25lm	Fitting - 12v DC Driver - 240v AC		6x 0.5w Built in LED	9350418038227



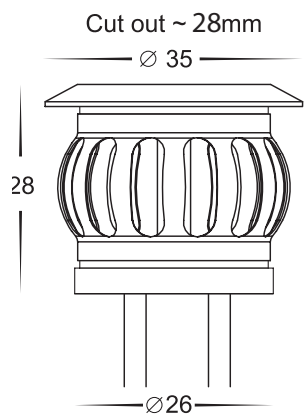



Dimensions



Optional Havit Compatible Accessories

Image	Part Number	Description
	12v DC LED Drivers	2m extension cable to extend length between fittings
	HV2826-EXT-CCT-2M	2m extension cable to extend length between fittings
	HV2826-EXT-CCT-4M	4m extension cable to extend length between fittings
	HV2826-D-12W	12w LED Driver to suit
	HV9971	Stainless Steel Maintenance Kit - Kit includes rejuvenating paste + spray for final protection coating

Examples of Compatible CCT Controllers

Touch Panels	Remote Controllers	Zigbee	RF + WiFi
 HV9101-E55	 HV9101-EX85	 HV9101-ZB-5C	 HV9105-1009-5C
	 HV9102-M2+M4+5A	 HV9105-ZB-5C	

Scan QR Code below to see the full range of compatible CCT LED Strip Controllers



Scan to explore full range of CCT Controllers