

Nella Aluminium Surface Mounted Downlights

Name	Nella
Material	Aluminium
Colour	Black or White
IP Rating	IP54
IK Rating	IK08
Installation Type	Ceiling - Surface Mounted
Diffuser Type	Plastic
Lamp Base	Built in LED
Max Wattage	18w
Protection Class	240v = 1 (Requires Earth) 12v DC = 3 (No Earth Required)
Lamp Expectancy	<30,000hrs
CRI	CRI>80
Dimmable	Yes - Triac (240V Models Only)
Warranty	3 Years Replacement

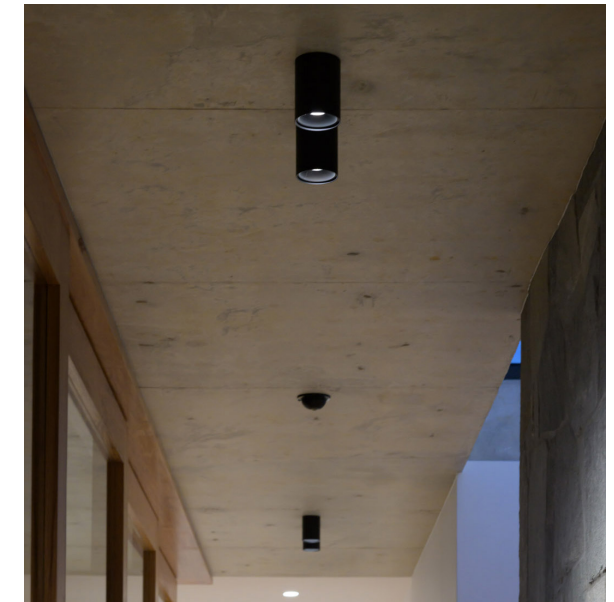

Dimensions

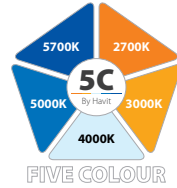
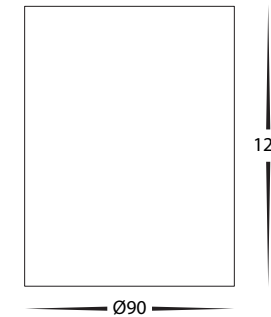

Mounting Base

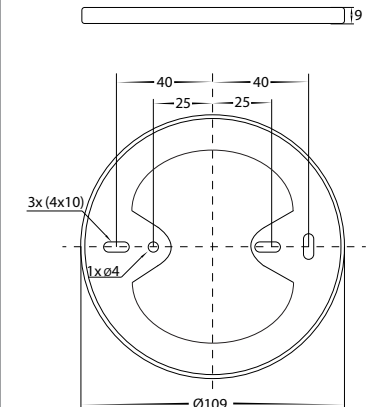

Product Ordering

Image	Part Number	Colour Temp	Lumens	Input Voltage	Beam Angle	Included LED	Barcode
	HV5843S-BLK	2700k 3000k 4000k 5000k 5700k	1371lm 1410m 1518lm 1600lm 1617lm	240V AC	60°	Five Colour 18w Built in LED	9350418028648
	HV5843S-BLK-12V			12V DC			9350418033055
	HV5843S-WHT			240V AC			9350418028655
	HV5843S-WHT-12V			12V DC			9350418033062



Warranty
Terms & Conditions

Website

White



Gold Insert



Black Insert



Chrome Insert



HV5843-WHT-PDT
3M Pendant Accessory



Black

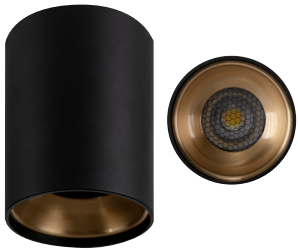

Gold Insert



Chrome Insert



HV5843-BLK-PDT
3M Pendant Accessory

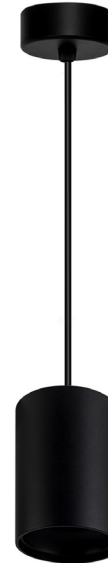

Pendant Line Drawing

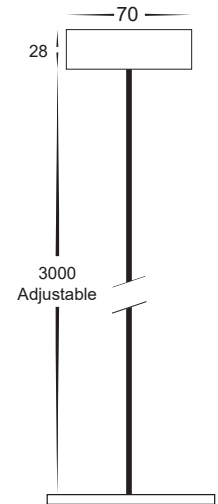

Optional Compatible Havit Accessories

Image	Part Number	Description	Barcode
	HV5843-GR	Gold Insert	9350418028662
	HV5843-BR	Black Insert	9350418028679
	HV5843-CR	Chrome Insert	9350418028686
	HV9625	Triac Dimmer	9350418001795
	HV5843-BLK-PDT	3M Pendant Accessory	9350418035738
	HV5843-WHT-PDT	3M Pendant Accessory	9350418035745

Compatible Drivers for 12v DC Models

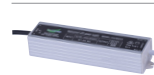

12v DC
LED Drivers

See Catalogue or Website for full range of
12v DC LED Drivers



Compatible
Drivers



Warranty
Terms & Conditions



Website