

LTECH

HAVIT  
Lighting

# E Series Touch Panel



E1  
(Dim)

E2  
(CT)

E4  
(RGBW)

E4S  
(RGBW)

E5S  
(RGBWY)

Qseries  
remote

Fseries  
remote

Mobile  
app

Manual

[www.havit.com.au](http://www.havit.com.au)

## L-BUS

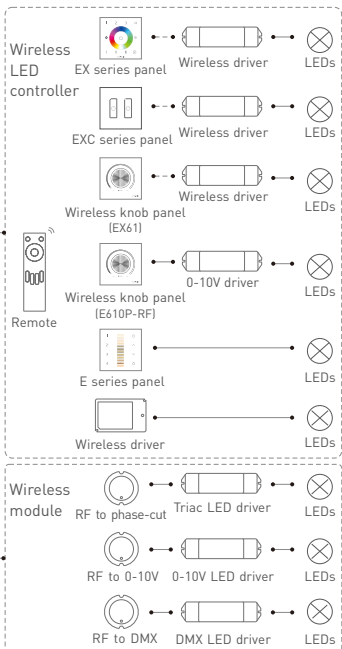
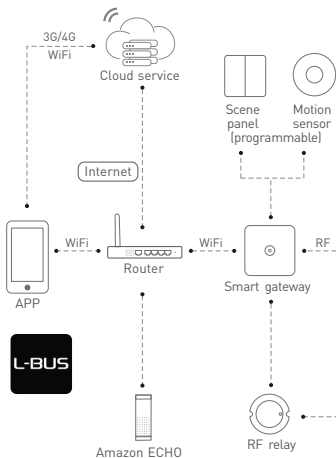

## Product Features

**LTECH**

- 2 in 1 function: RF wireless control and PWM power output.
- Power output, lamps can be connected directly, easy and convenient.
- Touch keys with chord and LED indicator.
- Adopt capacitive touch control technology on the full color circle that makes LED dimming selection more user-friendly.
- Touch panel can be controlled by remote directly or smart phone if adding a gateway.

## Technical Specs

Model	E1	E2	E4 / E4S	E5S
Control Type	Dimming	CT	RGBW	RGBWY
Input Voltage	12-24Vdc			
Wireless Frequency	RF 2.4GHz			
Current Load	4A×2CH Max. 8A	Max. 4A	3A×4CH Max. 12A	3A×5CH Max. 15A
Output Power	(0~48W...96W)×2CH Max. 192W	0~48...96W	(0~36W...72W)×4CH Max. 288W	(0~36W...72W)×5CH Max. 360W
Protection	Short circuit/Over current protection, auto recovery. Reverse connection protection.		Reverse connection protection.	Reverse connection protection.
Working Temp.	-20°C~55°C			
Dimensions	L86×W86×H36(mm)			
Package Size	L113×W112×H50(mm)			
Weight(G.W.)	235g	231g	221g	221g

\* Product with **L-BUS** logo, supports the function of WIFI-108 advanced mode.  
Advance Mode



RoHS



# Installation Instructions

LTECH

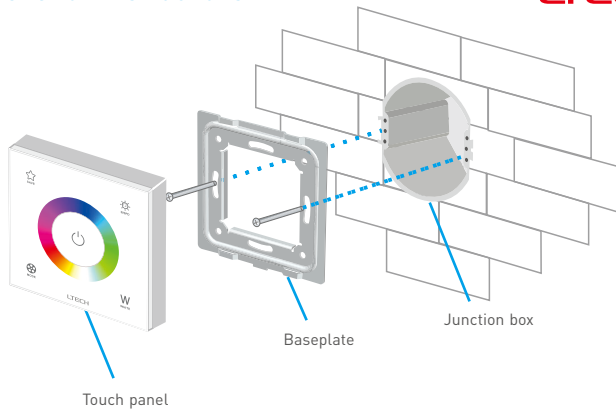

Typical junction boxes are as follows:

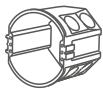

European style

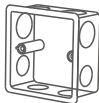

86 type



## Product Size

LTECH

Unit: mm

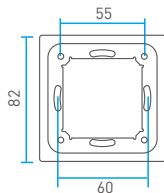
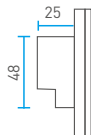
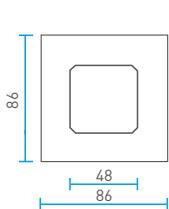



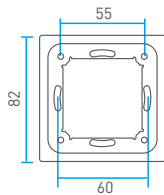
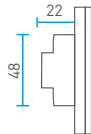
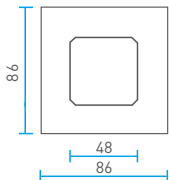

E1 / E2



E4 / E4S / E5S

# Key Functions

When blue indicator light of  key is on, long press  to turn on/off buzzer.

When white indicator light of  key is on, long press  to match code.

E series touch panel's scene-mode keys are corresponding with WiFi gateway APP's scene-mode, the scenes of panel can be changed by APP or panel.

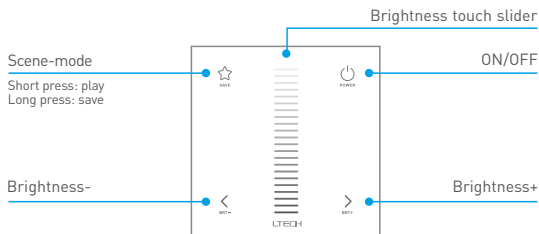

E1

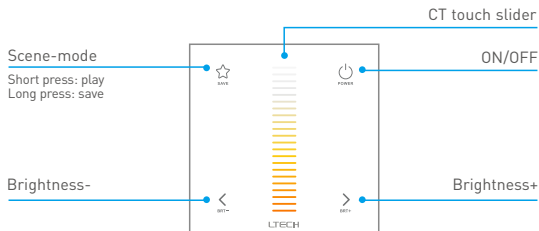

E2

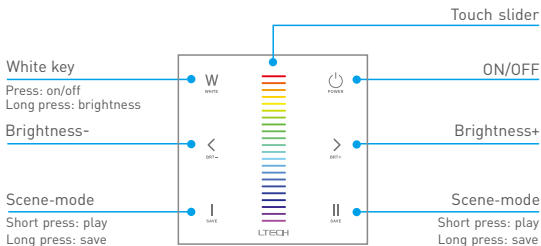

E4



E4S

## E4S Mode

- Static red
- Static green
- Static blue
- Static yellow
- Static purple
- Static cyan
- Static white
- RGB jumping
- 7 color jumping
- RGB gradient
- 7 color gradient
- Static black
- Close RGB only

## Scene-mode

Short press: play  
Long press: save

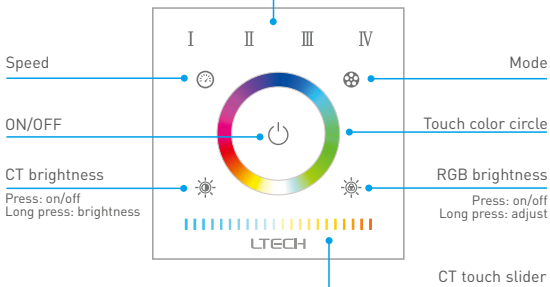

E5S

## Mode

- Red green jumping • Green blue jumping • Red blue jumping • RGB jumping • 7 color jumping
- Red green gradient • Green blue gradient • Red blue gradient • RGB gradient • 7 color gradient



# System Diagram

LTECH

PS: No WiFi router is needed when gateway work with phones directly.

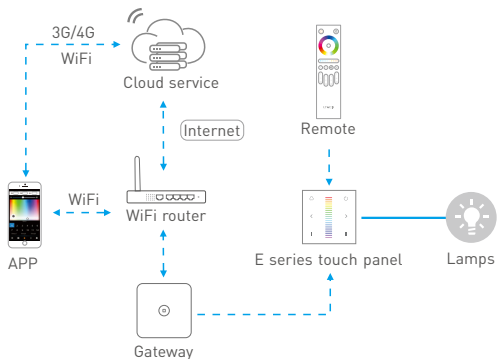

## Applications

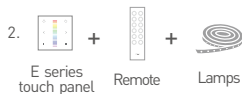
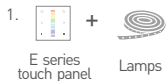

## Single Zone Control

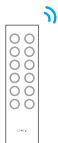

Single zone remote

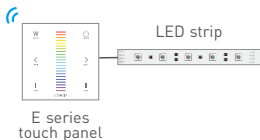

E series touch panel

## Multiple Zone Control



4 zone remote

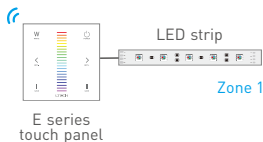

E series touch panel

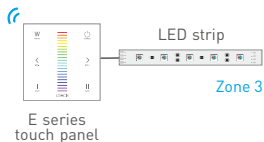

E series touch panel

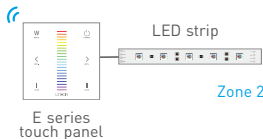

E series touch panel

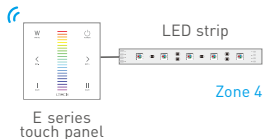

E series touch panel

\* Touch panels can be sync controlled by multi remotes, please refer to the manual of remote's usage.

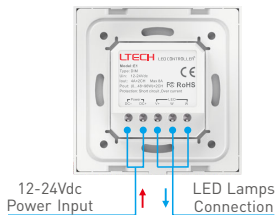

E1

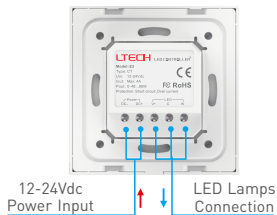

E2

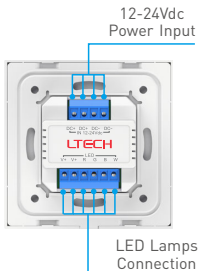

E4/E4S

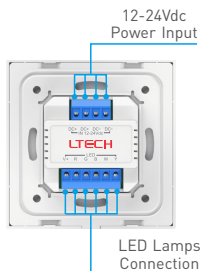

E5S

## Wiring Diagram

**LTECH**

E1: Connect with 12V strip. Max 48W/CH

Connect with 24V strip. Max 96W/CH

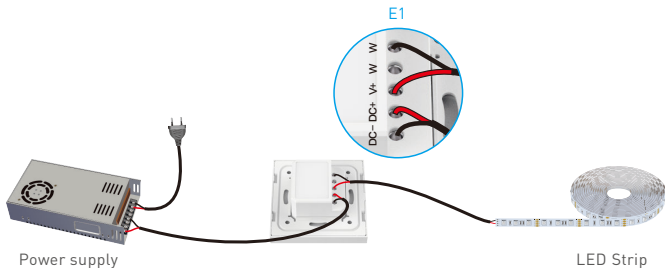

E2: Connect with 12V strip. Max 48W for two routes.

Connect with 24V strip. Max 96W for two routes.

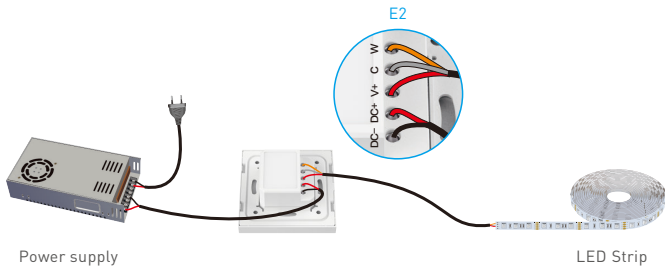

E4/E4S: Connect with 12V strip. Max 36W/CH  
Connect with 24V strip. Max 72W/CH

LTECH

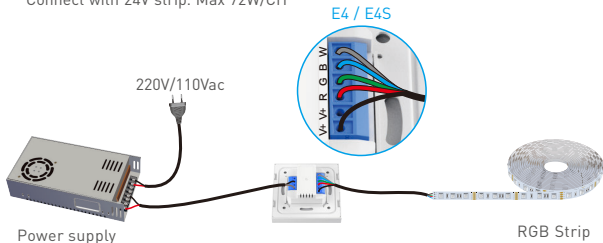

E5S: Connect with 12V strip, RGB Max. 108W, CT Max. 36W  
Connect with 24V strip, RGB Max. 216W, CT Max. 72W

RGB Strip E5S RGB/CT Strip

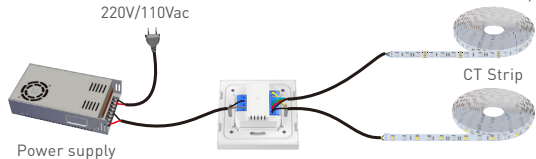

E5S RGBWY Strip

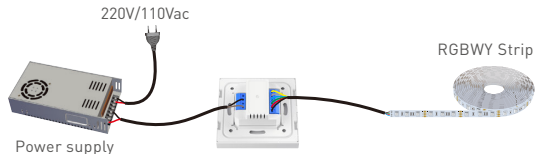

# Match Code between Touch Panel & Remote

**LTECH**

Please match/clear code when panel indicator light of On/Off is white.

1. Long press  on touch panel until indicator lights flash.



E1



E2



E4



E4S



E5S

2. Match code with F series remote:

Single zone remote: long press ON/OFF key on remote, the indicator light stops flashing, match code successfully.

Multi-zone remote: long press the matching zone's ON & OFF keys simultaneously, the indicator light stops flashing, match code successfully.



F1  
(Dim)



F2  
(CT)



F3  
(RGB)



F4  
(RGBW)



F5  
(Dim)



F6  
(CT)



F7  
(RGB)



F8  
(RGBW)

E1 touch panel match with F1/F5 remote, E2 match with F2/F6, E4/E4S match with F4/F8.

Match code with Q series remote: long press the matching zone's "ON" key on remote, the indicator lights of touch panel stop flicking, match successfully.



Q1



Q2



Q4



Q5

E5S touch panel match with Q5 remote.

# Match Code between Touch Panel & Gateway

**LTECH**

Please match/clear code when panel indicator light of On/Off is white.

1. Long press  on touch panel until indicator lights flash.

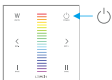
**E1****E2****E4****E4S****E5S**

2. Turn on APP, enter “zone set” interface, click the right top “MATCH” key, then operate the following prompts.



## Clear Code

Please match/clear code when panel indicator light of On/Off is white.

Press the bottom two keys on touch panel simultaneously for 6 seconds, the indicator light flashes several times, clear code successfully.



\* This manual is subject to changes without further notice. Product functions depend on the goods. Please feel free to contact our official distributors if you have any question.

- Warranty periods from the date of delivery 5 years.
- Free repair or replacement services for quality problems are provided within warranty periods.

Warranty exclusions below:

- Beyond warranty periods.
  - Any artificial damage caused by high voltage, overload, or improper operations.
  - Products with severe physical damage.
  - Damage caused by natural disasters and force majeure.
  - Warranty labels and barcodes have been damaged.
  - No any contract signed by LTECH.
1. Repair or replacement provided is the only remedy for customers. LTECH is not liable for any incidental or consequential damage unless it is within the law.
  2. LTECH has the right to amend or adjust the terms of this warranty, and release in written form shall prevail.

