



TEMPEST CEILING FAN

Installation Manual



- 99983/05: TEMPEST Ceiling Fan – White
- 99983/06: TEMPEST Ceiling Fan – Black
- 99983/13: TEMPEST Ceiling Fan – Brushed Chrome
- 99983/14: TEMPEST Ceiling Fan – Oil Rubbed Bronze

MUST BE INSTALLED BY A QUALIFIED ELECTRICAL CONTRACTOR

YOUR BRILLIANT TEMPEST CEILING FAN:

Congratulations on the purchase of your new quality Brilliant Ceiling Fan. Before first using, it is most important that you read and follow the instructions in this use and care booklet, even if you feel you are quite familiar with this type of product.

Find a place and keep this booklet handy for future reference.

IMPORTANT SAFEGUARDS:

Read all instructions carefully, even if you feel you are quite familiar with this type of appliance. When using electrical appliances, in order to reduce the risk of fire, electric shock, and/or injury, these basic safety precautions should always be followed:

1. This appliance **MUST** be installed by a Qualified Electrical Contractor in accordance with the local regulations, and all local, state and national electrical codes. Any alterations or additions to building wiring must be completed by a licensed electrical mechanic, or person authorised by legislation to work on the fixed wiring of any electrical installation.
2. The ceiling fan must be connected to a 240V AC 50Hz power supply.
3. All electrical work must only be undertaken after disconnection of the power by removing fuses or turning off the circuit breaker, to ensure all pole isolation of the electrical supply.
4. The fan must be earthed.
5. The fan must be installed so that the blades are **more than** 2.1 metres above the floor.
6. The structure that the ceiling fan is connected to must be capable of supporting a weight of at least 45kg. The fixing must be able to support the moving weight of the fan and must not twist or work loose.
7. Make sure that the installation site will not allow the rotating fan blades to come into contact with any object and that there is a minimum clearance of 150mm (6") from the blade tip to the wall or ceiling. Please note that the bigger this clearance is the better the airflow from your fan will be.
8. **DO NOT** use outdoors. Installing the fan in a position where it could be exposed to water or moisture is dangerous. Refer to Warranty for Alfresco use.
9. **DO NOT** connect the fan motor to a dimmer switch. This may give an unsatisfactory performance (motor hum) and cause damage to the motor.
10. This appliance is not intended for use by young children or infirm persons without supervision.
11. Young children should be supervised to ensure they **DO NOT** play with the appliance.
12. It is not recommended that ceiling fans and gas appliances be operated in the same room at the same time.
13. The fan must be turned off and stopped completely before reversing the fan direction. This will prevent any damage to the motor of the fan or controller (if installed).
14. Do not insert anything into the fan blades whilst they are spinning. This will damage the blades and upset the balance of the fan causing the unit to wobble.
15. After the fan is completely installed make sure that all base and fan blade fixations are secured and tightened to prevent any problems.
16. A blade balancing kit is included. Ensure blades are balanced immediately after installation to reduce wobble and noise.
17. Because of the fan's natural movement, some connections may loosen. Check the support connections, brackets and blade attachments twice a year to make sure they remain secured. If any are loose, tighten.
18. **DO NOT** use a solid-state dimmer type fan controller. Use **ONLY** the provided switch controller for fan speed control.

IMPROTANT NOTE:

The important safeguards and instructions given in this manual are not meant to cover all possible conditions and situations that may occur. It must be understood that common sense, caution and care are factors which cannot be built into any product. The persons caring for and using the unit must supply these factors.

FAULT FINDER:

- Always check the "Trouble Shooting Checklist" included in this booklet before seeking warranty claim.
- Mechanical noise may be noticed on installation. Allow at least 8 hours settling-in period.
- Some fans may wobble more than others, even if they are the same models. This does not necessarily indicate a fault.

PREPARATION:

- Unpack your ceiling fan carefully, then remove all parts and components, and lay on a cloth or soft surface to avoid damage. **DO NOT** lay the motor housing on its side, the housing may get damaged.
- Before commencing installation, check that all parts are included. NB: You may need to remove all foam packaging material to ensure there are no missing components.

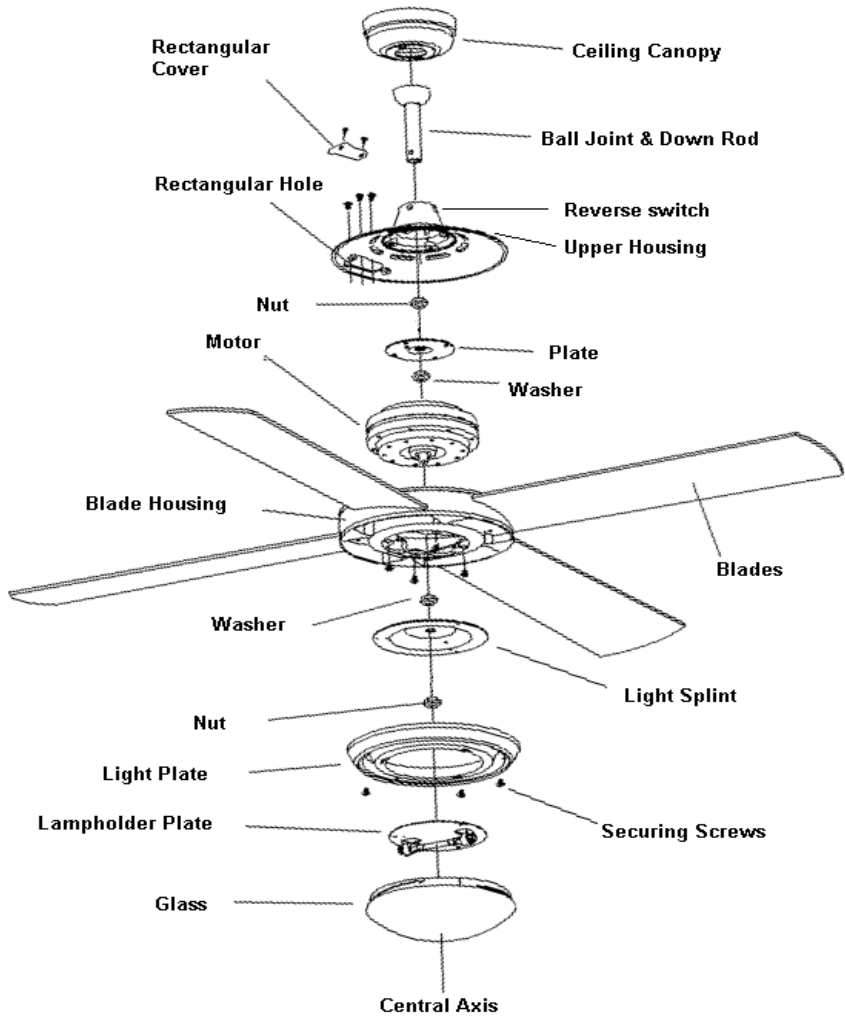

SELECTING A LOCATION:

- Choose a location for mounting the fan where the blades will have **at least** 2.1 metres of clearance from the floor.
- Make sure that the installation site will not allow the rotating fan blades to come into contact with any object and that there is a minimum clearance of 150mm (6") from the blade tip to the wall or ceiling. Please note that the bigger this clearance is the better the airflow from your fan will be.
- DO NOT use outdoors. Installing the fan in a position where it could be exposed to water or moisture is dangerous.
- If the location you have chosen does not have a suitable support beam capable of supporting 45Kg, install a brace 2" x 4" between the ceiling joists as a support medium.

ASSEMBLY:

Unlike most ceiling fans, the Brilliant Tempest Ceiling Fan requires you to attach the blades to the motor **BEFORE** mounting the motor to the ceiling.

If installing more than one ceiling fan, ensure that the blades do not get mixed up between units, as each set is dynamically balanced.

BLADE ATTACHMENT:

1. Remove the two screws from the covering plate on top of the motor housing (Fig. 4), and remove the plate.
2. Insert the blade through the slots around the motor. Align the blade with the three holes, and secure the three screws through the opening exposed when the covering plate was removed. If the holes do not align, the blade is upside down. The blade is designed to fit snugly, the screws should be vertical with the blade.
3. Tighten all blade screws evenly and securely to ensure quiet, wobble free operation of the fan.
4. Replace the covering plate on top of the motor housing by reversing step 1.

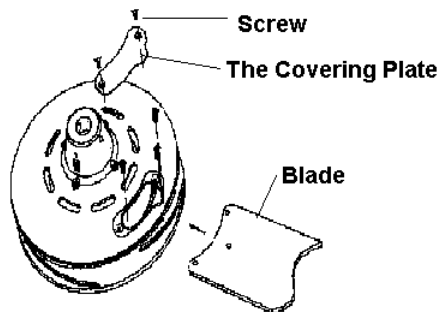

INSTALLATION:

CAUTION: Before installing the fan, make sure you have turned OFF the electricity supply.

1. Secure the hanging bracket to the ceiling joist or suitable structure that is capable of carrying a load of at least 45Kg, with the two long fixing screws provided. Ensure that at least 30mm of the screw is threaded into the support.

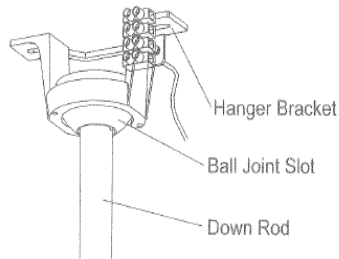

NB: The fixing screws included are designed for use when ceiling fan is secured onto timber joists. For all other surfaces, additional and suitable fixing screws for that surface will need to be purchased.

2. Make sure that the position of installation will not allow the blades to come into contact with any object. The fan must be mounted so that the tips of the blades are **at least** 2.1 metres above the floor.

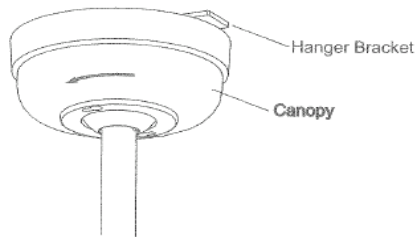

3. Carefully lift the fan, and place the down rod ball assembly into the mounting plate ensuring that the ball correctly locks into place.
4. Refer to the following section detailing "Electrical Connection" for details on how to wire this product correctly.
5. After the fan has been wired to the power supply, carefully position all excess cable inside the boundaries of the hanging bracket.
6. Carefully slide the canopy up to cover the hanging bracket and ball joint, taking care not to damage wires. Once in position, secure the canopy with the screws provided.

ELECTRICAL CONNECTIONS:

For your convenience, and to assist in easy installation & cleaning, your ceiling fan is connected with Brilliant's easy connect system. Simply connect the male and female couplings, and then ensure all excess wiring is retained inside the ceiling canopy.

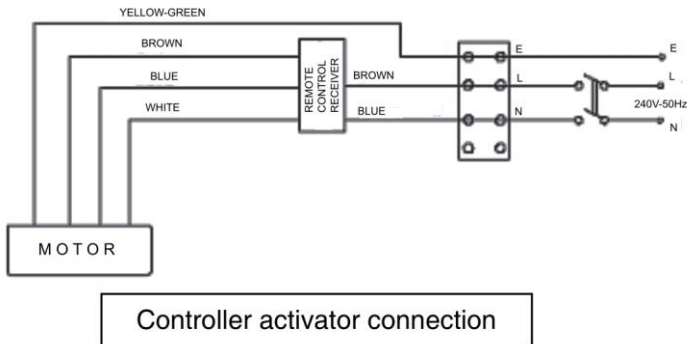
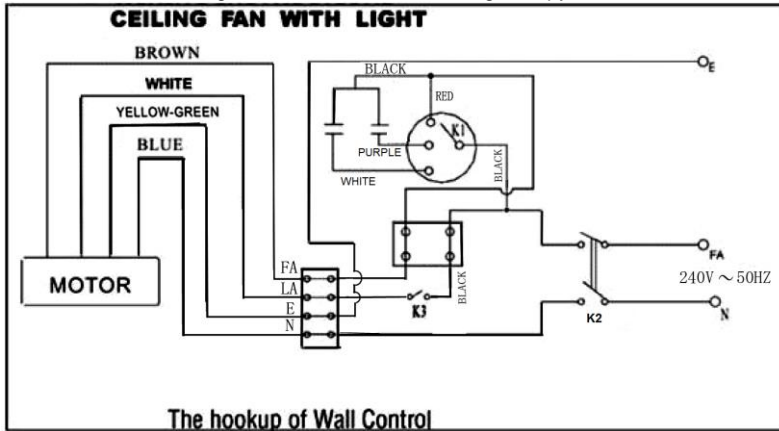

INSTALLING THE GLOBE (99984):

- Only 100W 78mm R7s Quartz Linear Halogen tubes can be used with the Tempest Ceiling Fan. Higher wattage's will void your warranty, and may damage your ceiling fan.
- To insert the globe, insert one end of the globe first, then the other end.
- DO NOT touch the globe with your bare hands; always use a tissue or rubber gloves when handling globe.

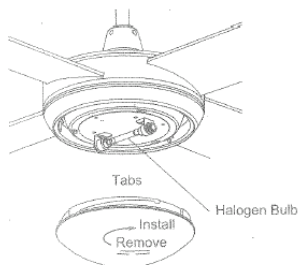

REVERSE SWITCH:

The “Summer / Winter” switch should be in the forward position to make the fan rotate in an anti-clockwise direction during summer. In winter,, this switch should be reversed (move to UP position) so that the blades now move in a clockwise direction.

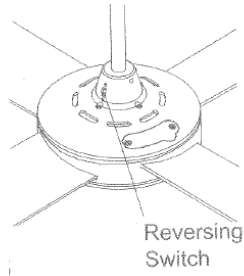

FITTING COVER: (99983 – No Light)

For models without a light, the bottom cover is fitted as shown below using the washer, and turning the cover in a clockwise direction.

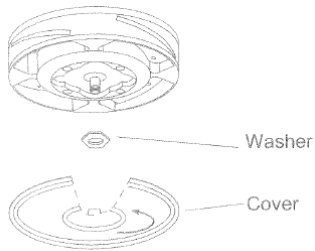

REMOVING COVER: (99983 – No Light)

For models without a light, the bottom cover is removed by turning the cover in an anti-clockwise direction. (as shown)

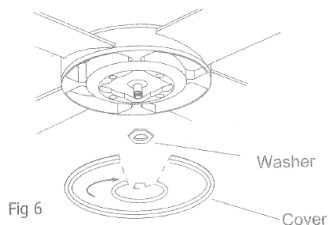

Fig 6

CARE & CLEANING:

- Periodic cleaning of your ceiling fan is the only maintenance required.
- Use a soft brush or lint free cloth to avoid scratching the finish. Please turn off electricity when you do so.
- Do not use water when cleaning your ceiling fan. It could damage the motor or the wood blades and create the possibility of an electrical shock.
- The motor has a permanently lubricated ball bearing, and as such is maintenance free.

NOISE:

The manufacturer warranty covers actual faults that may develop, but NOT minor complaints, e.g. hearing slight noise from motor in operation - ALL ELECTRIC MOTORS ARE AUDIBLE TO SOME EXTENT, more so, when the fan is operating at low speeds.

WOBBLE:

- Ceiling fans are mounted very securely on steel brackets with rubber cushioning or with ball joints to allow free movement.
- Ceiling fans are designed to move during operation because they are not generally rigidly mounted - if they were, they could generate excessive ceiling vibration and stress on their mountings.
- Movement of a couple of centimetres is quite OK and does not suggest the fan will fall down.
- Please note that all ceiling fans are not the same, even in the same model - some may move more or less than others.

NORMAL WEAR AND TEAR:

Threaded components working slightly loose or blade carriers even slightly bent due to vigorous cleaning or bumping can cause extra wobble and noise. THIS IS NOT COVERED UNDER WARRANTY but a little care and maintenance can reduce or prevent this problem.

TROUBLESHOOTING:

TROUBLE	PROBABLE CAUSE	SUGGESTED REMEDY
Fan will not start	A/ Fuse or circuit breaker has blown.	A/ Check main and branch circuit breakers.
	B/ Loose wire connections to the fan.	B/ Check line wire connections to fan.
	C/ Speed controller not in the correct position.	C/ Check speed controllers position.
Fan wobbles	A/ Fan blades are not horizontal to the ceiling.	A/ Retighten all screws on blades. Do not make any adjustments by applying pressure up or down on blades.
	B/ Blade screws are loose.	B/ Make sure all screws are tightened.
Fan sounds noisy	B/ Loose fan blades.	B/ Retighten all screws on fan.
	C/ Ceiling fan not secured against ceiling.	C/ Retighten all screws in the hanging bracket.
	D/ Incorrect speed controller.	D/ Change speed controller to the one supplied with the unit.
Mechanical noise	A/ Fan has not settled in fully.	A/ Allow at least 8 hours settling in period.

BALANCING:

1. This fan includes a blade balancing kit. Upon initial installation, the balance kit should be used on the fan blades to reduce wobble.
2. The balance kit includes instructions on how to perform the balancing procedure.
3. Balancing the fan and reducing wobble will result in quieter operation and optimum performance.

WARRANTY CONDITIONS:

- Installation must be performed by a qualified and licensed electrician. The warranty will not apply if the ceiling fan is installed by other than a licensed electrician. Problems arising from incorrect installation are not covered by warranty. The cost of repairs and / or service call arising from incorrect installation, not due to faulty material or workmanship in accordance with the Brilliant warranty, will be payable by the purchaser at the time of repair.
- This warranty is only valid for appliances used according to the manufacturer's instructions.
- The manufacturer does not accept liability for any direct or consequential damage, loss or other expense arising from misuse or incorrect installation and operation of the appliance.
- Warranty will only be provided where proof of qualified electrical installation is provided. Eg. Electrical Safety Certificate.
- The manufacturer will not accept in home expenses unless authorisation is granted prior to work commencing, and a CA number allocated.
- The in-home component of this warranty covers only actual electrical work undertaken, on or to the ceiling fan.
- Where a service call is undertaken and no fault is found with the ceiling fan, or where the fault is not covered under the terms of this warranty, a call-out fee may be charged.
- This product is not designed or intended for industrial or commercial use.



Brilliant Fan Warranty

Please note, this warranty voids any other warranties supplied with this product and complies with the new consumer guarantee requirements.

WARRANTY:

The benefits conferred by this warranty are in addition to all implied warranties, other rights and remedies in respect of the product, which the consumer has under Australian Consumer Law.

The original purchaser of this Brilliant Ceiling Fan is provided with the following warranty subject to the following conditions.

Brilliant Lighting (Aust) Pty Ltd warrants this ceiling fans motor for a period of 5 years from the date of purchase, the first 2 years are covered by an in-home warranty. All parts deemed defective in workmanship or materials will be replaced free of charge.

The warranted use of fans outdoors are limited to Enclosed Alfresco like areas where conditions are similar to indoor installations. The warranty conditions for fans installed in Enclosed Alfresco areas are as follows: Fan must be shielded from wind and rain (enclosed area, min. 1.5m from edge of eave/roof).

The warranty will cover open circuit motor faults, and remote control faults if not related to outdoor exposure.

The Warranty will not cover outdoor related issues such as rusting, or failure clearly caused by water, moisture or wind.

The Warranty will not cover external appearance or finish of any part of the ceiling fan.

The Warranty will not cover wooden bladed fans. These are recommended only to be used indoors.

This warranty is in addition to any other rights and remedies of the customer under any law. In applications not intended for household, personal or domestic use, liability is limited to replacement or reimbursement of product only.

Our goods come with guarantees that cannot be excluded under the Australian Consumer Law. You are entitled to a replacement or refund for a major failure and compensation for any other reasonably foreseeable loss or damage. You are also entitled to have the goods repaired or replaced if goods fail to be of acceptable quality and the failure does not amount to a major failure.

Any claim under this warranty must be made within 5 years of the date of purchase of the product. To make a claim under the warranty, take the product (with proof of purchase – receipt or similar) to the store where you purchased the product or contact Brilliant Lighting at the address below.

This warranty is given by:

Brilliant Lighting (Aust) Pty. Ltd.

ABN 37 006 203 694

956 Stud Road Rowville, VIC 3178

Phone: 03 9765 2555

Email: info@brilliantlighting.com.au

MADE IN CHINA